

(Front Bumper) INSTALLATION INSTRUCTIONS 2011-Current, Nissan NV

Please read before beginning

- Stainless steel hardware may bind together when tightening—It is recommended that you apply an anti-seize assembly lubricant to the threads of each bolt before assembly
- This installation requires two people
- If your bumper has sensors, you will use the factory sensor clips from your OEM bumper.



Required tools

- Standard wrench set
- Leveling tool
- Screwdriver Set
- Cut off wheel
- Chisel and Hammer

Included Parts/Subassemblies



x1
Fairlead Cover
 (preinstalled)

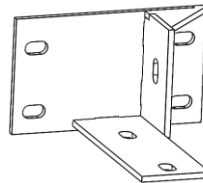
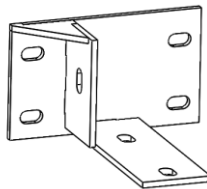

x2 (1 left, 1 right)
**Nissan NV Mounting
 Brackets**

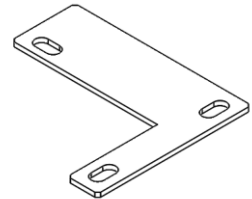

x2
**Lower Cover Bracket
 Nissan NV Slimline**

Included hardware

Quantity

- | | |
|--|----|
| • 70019 – 5/16-18 Nylock Nut, SS | 2 |
| • 70020 – 5/16" Washer, Zinc Plated | 4 |
| • 70022 – 5/16-18 x 1" Hex Head Bolt, SS | 2 |
| • 70024 – 3/8-16 Nylock Nuts, SS | 8 |
| • 70026 – 3/8" Washer, Zinc Plated | 16 |
| • 70029 – 3/8-16 x 1 ½" Hex Head Bolts, SS | 8 |
| • 70035 – ½" Washer | 4 |
| • 70056 – 7/16-14 Nylock Nut, Grade 8 | 2 |
| • 70057 – 7/16" Washer, Zinc | 4 |
| • 70092 – M12 – 1.25 X 40mm | 4 |
| • 70185 – 7/16-14 x 4 ½" Hex Head Bolts, Grade 8 | 2 |
| • 70259 -- 7/16" Bolt Sleeve | 2 |
| • Antiseize Packet, 2g | 1 |

Stock Bumper Removal

1. Remove the plastic inner fender by unscrewing the 7 screws on each side underneath the wheel well and just inward toward the center of the vehicle (**Figure 1**).



Figure 1. Remove 7 screws attaching the inner plastic fender.

2. With the plastic inner fender removed, you will have access to 2 different bumper support bars (**Figure 2**). One is flat and runs left to right from the frame to the inside of the bumper, and the other is curved and runs from the body mount to the bottom rear corner of the bumper. The long flat support bar is hooked into the frame so you might need to lift up on it before it can be removed.

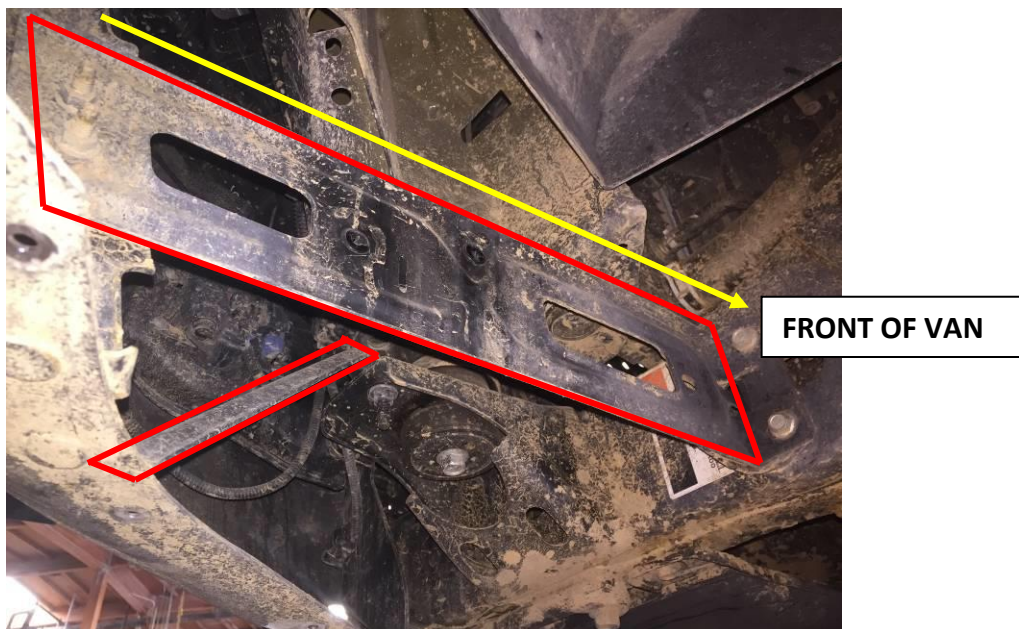

Figure 2. Remove two bumper support bars underneath the vehicle.

3. Remove the 6 bolts that hold on the skid plate.

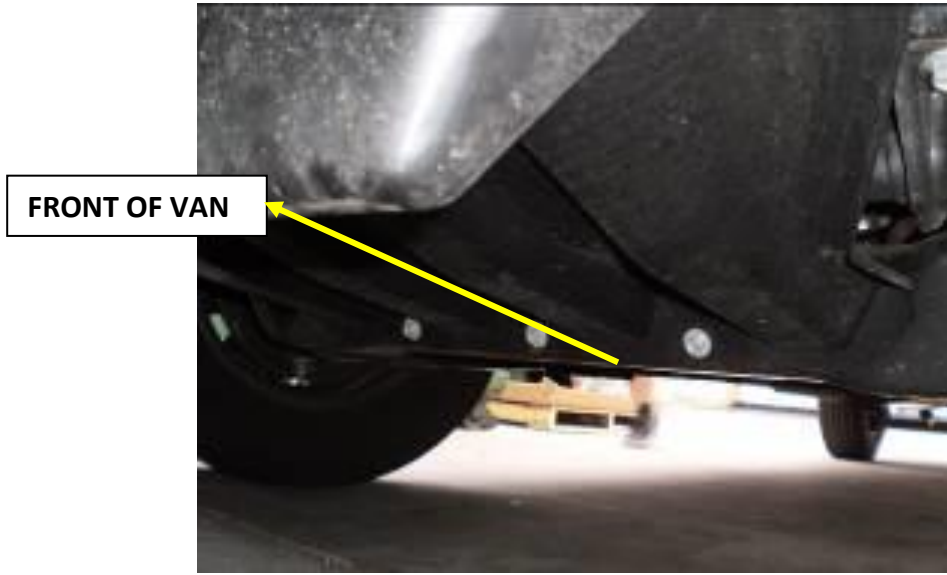

Figure 3. 6 bolts attaching the skid plate.

4. Once the skid plate is removed you will have access to 2 bolts on each side that hold another bumper support piece to the frame. Remove these 2 bolts from each side.

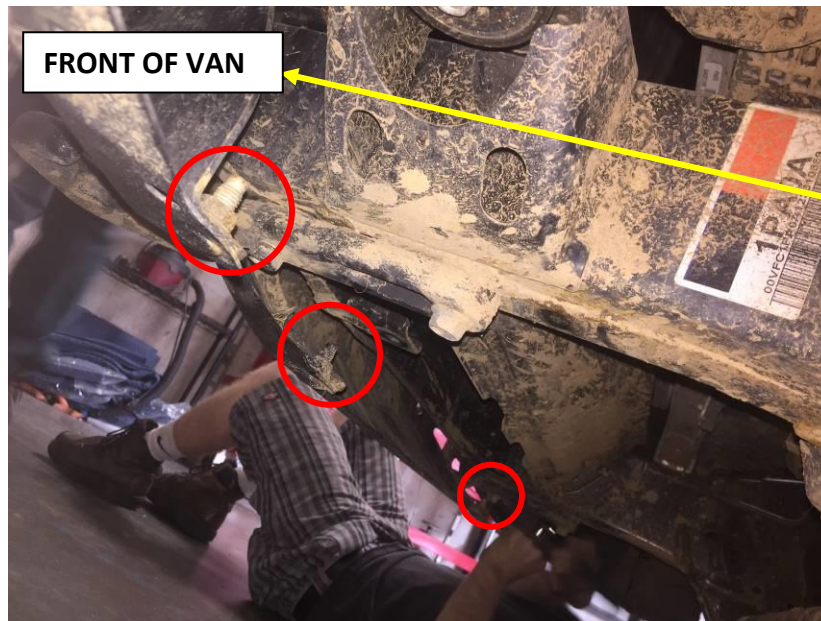

Figure 4. Bolts fastening the bumper to another support piece (4th bolt not pictured, out of frame to the left of the image)

5. Once the Skid Plate is removed you should be able to unbolt the main bumper structure. There are 3 bolts on each frame rail that are accessed through the front of the bumper. You will see a 4th bolt on

each side that does not actually hold the bumper on, but part of the inner bumper structure. Remove this bolt as well



Figure 5. View from the front of the vehicle, 4 more bolts on the main bumper structure.

6. Once you have removed these 6 bolts (3 on each side) then you will be able to take the main bumper off. 2 people should be involved in this step. The main bumper structure is hooked into the frame so you will have to lift up on it before you can slide it off.
 - a. NOTE: if you ordered your Aluminess Bumper with parking sensor's, you will need to retain the factory sensor housings from the OEM bumper.
7. Once you have the main bumper off you will be left with a crossmember and 2 frame horns which will need to be removed. Remove the 2 bolts holding the cooler lines to the crossmember.



Figure 6. Bolts attaching cooler lines to the front crossmember.

8. Remove the bolts that attach the faceplate (**Figure 7**) to the crossmember. Once the bolts are removed, you can lift the faceplate off so that only the crossmember is left.

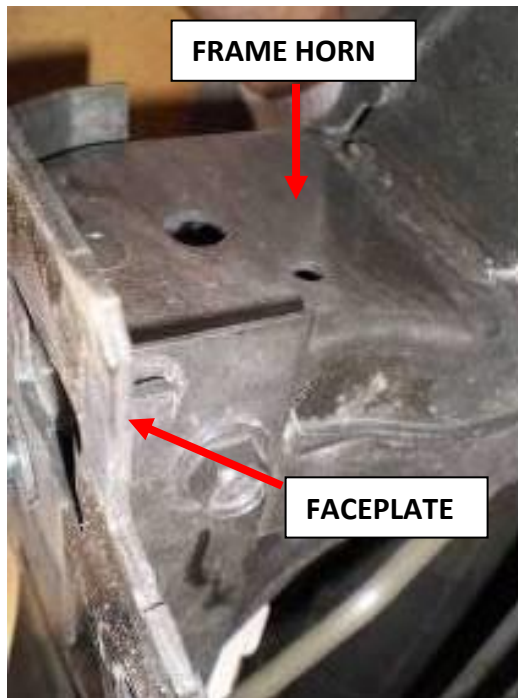

Figure 7. Remove faceplate before cutting welds on crossmember.

9. You will now need to cut the weld in order to remove the crossmember. Make sure to wear eye protection and be very cautious of sparks igniting things nearby. Slowly work the cutoff wheel up and down along the weld to break the crossmember free (**Figure 8a-b**).

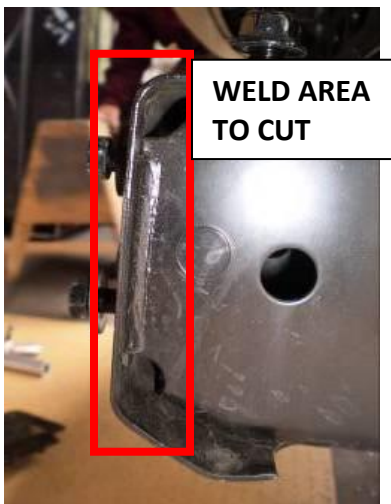

Figure 8a. Crossmember weld before cutting.



Figure 8b. Crossmember weld after cutting.

***NOTE:** If you are unable to get the cutoff wheel along the entire weld then it may be necessary to break the ends loose with a hammer and chisel.*

10. It is now time to install your Aluminess Bumper. First, bolt the steel brackets onto the frame horns as shown (**Figure 9**).



Figure 9. Steel angle brackets bolted to the passenger (left) and driver (right) frame horns.

11. Insert the provided 7/16-14 x 4 ½" bolts (70185) through the side of the frame with the 7/16" sleeve (70259) in the frame as a crush tube.
12. Before threading in the lower bolts into the bottom of the frame, line up the lower cover bracket (L-shaped) as shown in **Figure 10**. This will tie the frame into the existing plastic skid plate underneath your van.

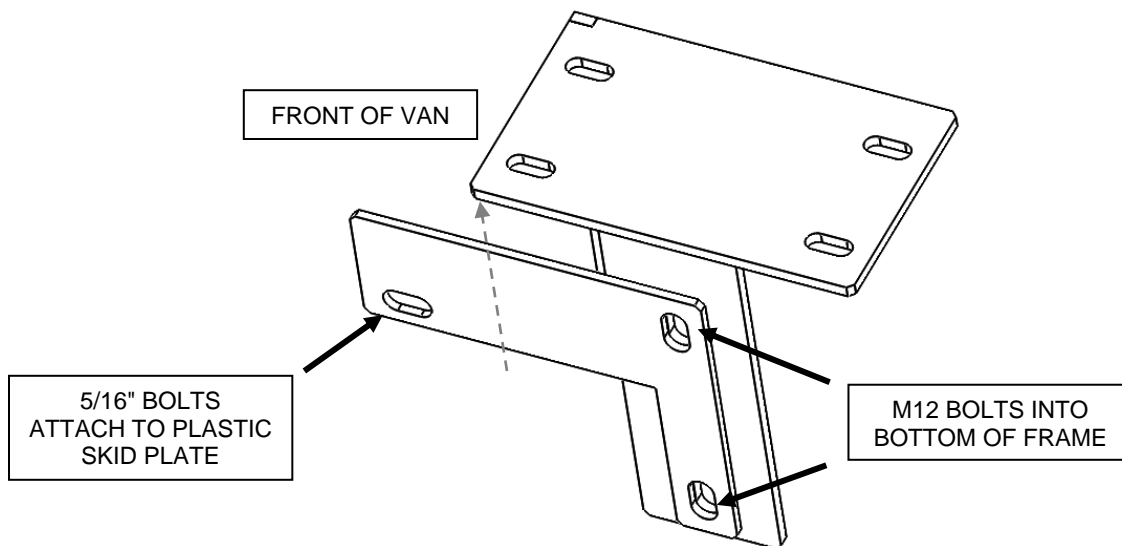

Figure 10. Lower cover brackets installed with mounting brackets.

13. Use the factory tow-hook bolts OR the provided M12-1.25 bolts and ½" washers to thread through the bottom of the brackets and into the vehicle frame.
14. Use the 5/16" hardware to attach the lower cover bracket to the skid plate underneath the vehicle.
15. With the help of at least one other person, hold the bumper up to the vehicle and align it with the frame. Use the provided 3/8-16 x 1 ¼" bolts (70029) to bolt the brackets to the bumper back plate.
16. Position into desired position and tighten all bolts.
17. Enjoy your new Aluminess bumper!



Aluminess Products, Inc. (Aluminess) Warranty

1. Lifetime Warranty. Aluminess provides a lifetime warranty of its products to the original retail purchaser provided such products are installed correctly according to the official Aluminess installation instructions. Any modification to the original product design, function or use of any Aluminess products will void the Aluminess warranty. Aluminess will have sole discretion to determine warranty eligibility for any and all Aluminess products sold to any purchaser.
2. Limited Remedies. Subject to any limitations and exclusions described herein, and subject to Aluminess' determination of warranty eligibility, Aluminess will remedy defects in product materials and/or workmanship of any product by repairing or replacing such defective product, which shall be within Aluminess' sole discretion, without charge for parts or labor. Aluminess may elect in its sole discretion not to replace a defective product and issue the purchaser a refund equal to the purchase price of any defective product or purchaser may elect to receive a credit (equal to such refund) toward the purchase of new Aluminess products. Repair or replacement of a defective product or providing a refund or credit to purchaser will be purchaser's exclusive remedy under this warranty. Damage to a purchaser's vehicle, cargo and/or any other person or property is expressly excluded from the Aluminess warranty.
3. Modification. Aluminess products are designed to be mounted to factory equipped vehicles. Aftermarket additions to such vehicle may or may not require modification of an Aluminess product. The Aluminess warranty does not extend to any Aluminess products that are modified to fit around other otherwise accommodate or be compatible with any aftermarket vehicle accessories or alterations. Aluminess does not guarantee fitment with any other aftermarket accessories or modified vehicle, and it is up to purchaser to determine fitment prior to purchasing any Aluminess product.
4. Damage. Damage to Aluminess products due to normal wear and tear, including, but not limited to, cosmetic issues and superficial scratches, or structural damage to an Aluminess product in connection with any vehicle collisions or other structural degradation in connection with the use of such vehicle (on road or off road) will not be covered by the Aluminess warranty. Additionally, any product user's misuse, neglect, overloading, improper maintenance or improper installation or repair of any Aluminess products are not covered under the Aluminess warranty.
5. Use of the Products. Aluminess products are designed for off road vehicle use. Installing Aluminess products on a vehicle may exceed the factory designed capabilities of such vehicle and could potentially lead to vehicle damage. Aluminess will not be responsible for any damage caused to a purchaser or user's vehicle or any vehicle accessories caused by the use of any Aluminess products. It is to the sole responsibility of purchaser to inspect and ensure that the intended vehicle and Aluminess products are suitable and compatible for travel on road and off road. No seller nor any manufacturer of Aluminess products will be liable for any loss, damage or injury directly or indirectly arising from the use of any Aluminess products. Before using any Aluminess products, the purchaser or user will determine the suitability of the product(s) for their intended use(s) and the purchaser or user shall assume all responsibility and risk in connection therewith.
6. DISCLAIMER. THE ALUMINESS WARRANTY IS EXPRESSLY MADE IN LIEU OF ANY AND ALL OTHER WARRANTIES, AND EXCEPT FOR THE ALUMINESS WARRANTY SET FORTH HEREIN, ALUMINESS MAKES NO WARRANTY WHATSOEVER WITH RESPECT TO ANY ALUMINESS PRODUCT, INCLUDING ANY WARRANTY OF MERCHANTABILITY AND FITNESS FOR A PARTICULAR PURPOSE, WHETHER EXPRESS OR IMPLIED BY LAW, COURSE OF DEALING, COURSE OF PERFORMANCE, USAGE OF TRADE, OR OTHERWISE. EXCEPT FOR PURCHASER'S LIMITED REMEDIES SET FORTH HEREIN, IN NO EVENT WILL ALUMINESS BE LIABLE FOR ANY LOST PROFITS, LOST SALES, OR FOR ANY CONSEQUENTIAL, DIRECT, INDIRECT, INCIDENTAL, SPECIAL, EXEMPLARY OR PUNITIVE DAMAGES OR FOR ANY OTHER DAMAGES OF ANY KIND OR NATURE.
7. Compliance. Aluminess cannot guarantee that its products comply with all Federal, State, and/or local laws. Purchaser is advised to review local vehicle codes for compatibility prior to purchase to ensure that the installation and use of any Aluminess products does not violate any applicable laws.
8. Warranty Claim Submission. Purchaser will responsible for returning any defective product to Aluminess for warranty consideration and purchaser may be responsible for all costs associated with shipping the product to and from Aluminess. Prior to returning any product for warranty, purchaser must contact Aluminess Products Inc. for proper authorization.