

# Ladder Installation Instructions

P/N 210572, 210572.1: 2019+ Mercedes Sprinter Rear Door Ladder, High Roof

## Before you begin:



- *Stainless steel (SS) hardware may bind together when tightening — apply an anti-seize assembly lubricant to the threads of each SS bolt before assembly*
- *Do NOT use an impact gun if this symbol is shown – doing so may strip or cross-thread bolts.*
- **Maximum load capacity is 100 lbs on ladder while travelling**

## Required Tools:

- Standard and metric wrench set
- Standard and metric socket set
- Torx bit set
- Isopropyl Alcohol
- Baby Soap or Dish Soap
- Clean Rag
- Tin Snips or Dremel Cut-Off Wheel
- Painter's Tape (optional)
- Spray Bottle (optional)
- Heat Gun or Blow Dryer (optional)

## Included Hardware:

P/N	Description	Quantity
70344	5/16"-18 x 1" Button Head Bolt, BLACK OXIDE, SS	4
70446	5/16"-18 x 1-1/4" Button Head Bolt, BLACK OXIDE, SS	2
70345	5/16" ID Washer, BLACK OXIDE, SS	12
70346	5/16"-18 Nylon-Locking Nut, BLACK OXIDE, SS	6
70448	5/16" ID Washer, .125" THK, BLACK OXIDE SS	4
70124	M8-1.25 x 40 mm	6
70111	5/16" ID Split Washer	6
70079	#10-32 x 1/2" Philips head bolt, SS	4
70004	#10-32 Nylon-Locking Nut, SS	4
70246	Antiseize Bolt Lubricant Packet, 2g	1
301311.1	Impact Resistant Tape, upper hinge	1
301311.2	Impact Resistant Tape, lower hinge	1
301311.3	Impact Resistant Tape, center	1
401021	Adjustable Door Limiting Strap	1
401022	Webbing Anchor, 1" Webbing	1



## Additional Parts:

Part Number:	Description:	Quantity:
301263.1 / 350649	Upper Hinge Bracket, <b>Driver</b>	1 ea.
301262.1 / 350651	Lower Hinge Bracket, <b>Driver</b>	1 ea.

### Picture:

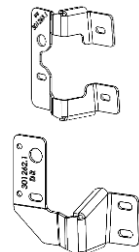

301264 / 350653 Inner Driver Door Bracket

1 ea.

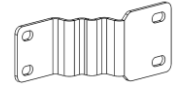

301265 / 350625 Latch Spacer (Rubber)

1 ea.

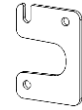

301257 / 350638 Hard Stop, Strap Bracket

1 ea.



301278 / 350676 Hard Stop, Strap Clamp

1 ea.



301258 M8 Machined Spacer

3 ea.



### Ladder Installation:

1. Clean the area around the center inside latch and each door hinge with soap/water first, and then with isopropyl alcohol.
2. Remove weather-stripping from the inside of the driver's side door.
3. Take a picture of the center, inside latch for later re-alignment (see Figure 1).



Figure 1: Factory Latch Alignment

4. Remove the center latch pin on the inside of the door as shown in Figure 2.

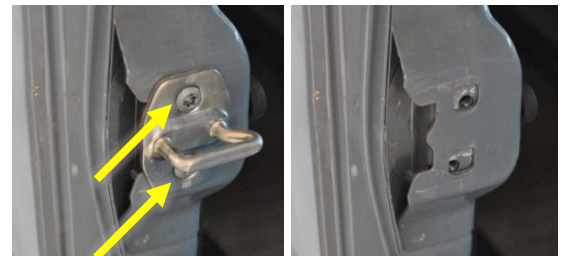

Figure 2: Driver's Side Inside Latch Pin Removal

### **Protective Tape Application:**

5. Cut the supplied protective tape into shape using the templates at the end of the installation instructions to provide additional protection for the door. Each bracket is designed to contact only at the door edges, but enough protective tape is provided to cover the entire overlapping area. Make sure that the sticky side is oriented correctly while cutting and applying (white backing towards vehicle). Reference Figures 3 & 4.
6. Dry-fit the corresponding brackets around the door in each location to find the desired position for the protective tape on the vehicle. Use painter's tape to outline application area of protective tape if desired.



Figure 3: Protective Tape Locations on Door

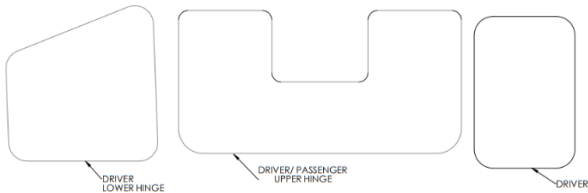

Figure 4: Template Examples (See End of Instructions for 1:1)

7. Apply the protective tape to each location, one at a time, using the method described below (wet application technique).
8. Prepare the surface for protective film application:
  - a. Clean the area around each hinge with isopropyl alcohol and rag.
  - b. Wash your hands thoroughly.
  - c. Do not apply in direct sunlight
  - d. Apply in temperatures above 60°F.
9. Spray the surface thoroughly with water and do not wipe down the surface.
10. Remove the liner from the protective tape while spraying the adhesive side with water.
11. Apply the protective tape to the outside of the door at the upper hinge, lower hinge, or center latching location. On the hinge side of the door,

leave approximately ½” of tape overhanging to be wrapped around the edge of the door (contact zone). Leave the tape overhanging for now.

12. Squeegee all air bubbles out starting at adhered edge. Press with your fingers first, and squeegee only if needed.
13. Wrap remaining protective tape around the door edge.
14. The adhesion process can be speed up by creating a 3:1 water-alcohol solution (3-parts water, 1-part alcohol) and spraying between the door and tape (lift section up and spray adhesive side).
15. If desired, use a heat gun or blow dryer to conform the tape to curved areas further.

**Bracket Installation:**

16. Install the sinner driver door bracket while re-aligning latch pin as close as possible to factory position (use previously taken picture as a guide).



Figure 5: Driver's Inside Door Latch Bracket Installed

**PRO TIP:** Before tightening factory torx bolts, slowly bringing your passenger door *near the closed position (not fully closed)* and verify vertical alignment of latch pin (driver door) to latch (passenger door). Only close door once product is fully installed.

17. Install the latch spacer on the passenger's side door by completing the following:

- a. Remove all the torx bolts from passenger side door latch.  
Note: The latch should remain within reach and not fall into door.



- b. Insert the upper part of the latch spacer between the door and the latch. Re-install the top right bolt through the spacer— **failure to reinstall this bolt now may allow the spacer to drop into door!**



- c. Fold the bottom into the door and rotate into place to align all bolt holes.



- d. Re-install the remaining factory bolts.



- e. Now the latch should not protrude past the sheet metal of the door.



18. Install the upper hinge bracket by:

- a. Remove only the lower torx bolt, *on the door.*



- b. Fit the upper hinge bracket over the hinge.



- c. Rotate into place.



- d. Fit the bracket over the upper torx bolt and rotate into desired position. Make sure the bracket is not contacting the sheet metal on the other side of the door, at either the top or the bottom of the bracket.



- e. Install a M8 bolt and 5/16" split washer into the bottom hole. Tighten the bolt to ~17 ft-lbs (23 Nm).



- f. Remove upper torx bolt and install a M8 bolt, 5/16" split washer, and **M8 machined spacer**.

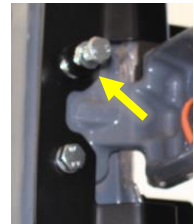

- g. Tighten down second bolt to ~17 ft-lbs (23 Nm)



19. Install the lower hinge bracket following the same procedure detailed in Step 18 and by installing over the hinge from the bottom up. Reference Figure 6.



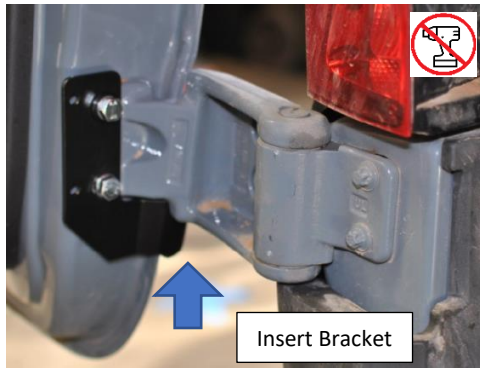

Figure 6: Lower Bracket Installed

**Limiting Strap Installation (Optional):**

20. Install the hard stop strap bracket onto the lower hinge by completing the following:

- a. Remove only the lower torx bolt, on the vehicle.



NOTE: A 8mm – 12 point socket may provide enough 'bite' to remove the two torx bolts. HOWEVER, do so at your own risk – using the improper tool for the job may result in stripping the bolts. Do NOT use an impact gun to remove these bolts.

- b. Install the bracket over the upper torx bolt with the provided M8 bolt and 5/16" split washer through the bottom hole. The larger hole must be on top. Tighten M8 bolt to ~17 ft-lbs (23 Nm).



- c. Remove the upper torx bolt and install a M8 bolt, 5/16" split washer, and **M8 machined spacer**.



- d. Tighten down second bolt to ~17 ft-lbs (23 Nm).

21. Install the adjustable door strap onto the hard stop bracket using the strap clamp to secure it. Feed the strap clamp through the largest eyelet in the strap and bolt it to the hard stop bracket. Direct the strap towards the lower hinge when tightening down the clamp. Reference Figure 7 and 8.

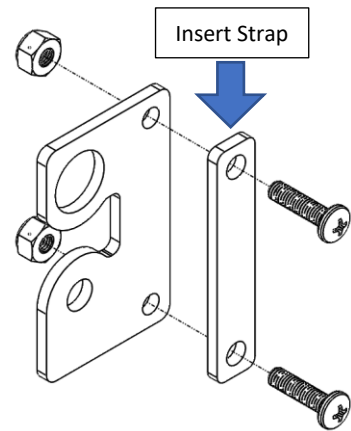

Figure 7: Adjustable Strap Clamp Assembly

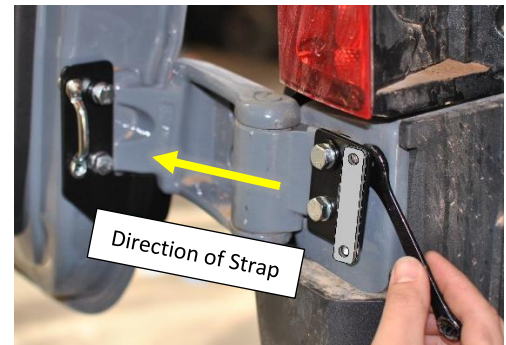

Figure 8: Strap Clamp Install onto Hard Stop Bracket

22. Open the door to the desired 'stopped' position, looking for clearance between the installed rear door product and the side of the van. Keep in mind additional tires/boxes/window flares that may be placed later.
23. Determine the closest available sewn loop on the adjustable strap – move to shorten the strap if in-between loops.
24. Install the webbing anchor onto the lower hinge bracket. Be sure to first thread the anchor

through the desired position on the adjustable strap (reference Figure 9 - 10).

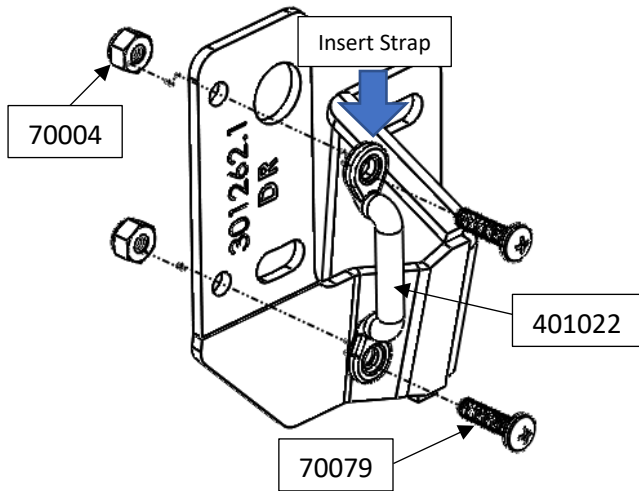

Figure 9: Installation of Webbing Anchor onto Bracket

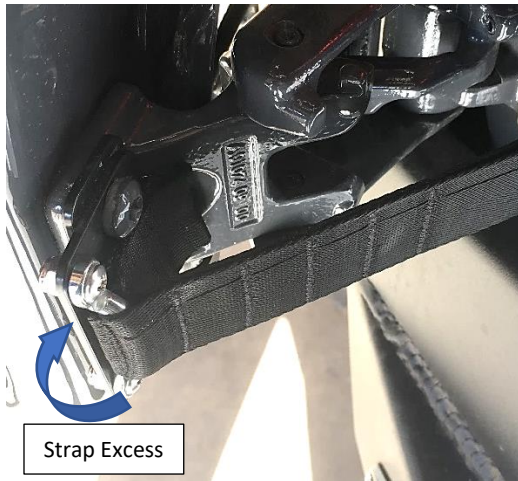

Figure 10: Adjustable Limiting Strap Installed

25. With the strap fully installed, verify clearances at the fully opened position between the product and the side of the van. Also verify clearances at the lower hinge as the door is slowly closed. Adjust strap as needed.

#### Ladder Installation:

26. Install the ladder using the provided black 5/16" bolts, washers, and nuts.

- e. Loosely install all bolts through bracket and ladder before tightening. Use the 1" bolts for the upper and lower hinge brackets and the 1-1/4" bolts for the center.

- f. Tighten the upper and lower **hinge** brackets first.
- g. There should be a small gap at the center bracket before tightening (0-1/8"). If the gap is larger than 1/8", use the provided 1/8" washers as shims (PN 70448) to close the gap to  $\leq 1/8"$  (See Figure 11).

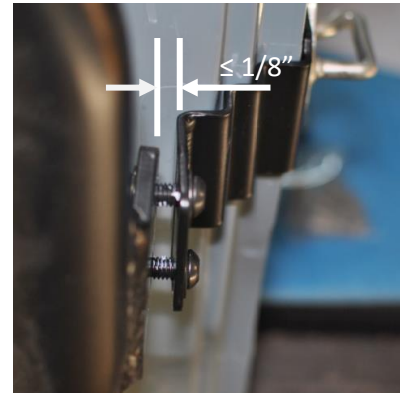

Figure 11: Gap Between Bracket and Product

27. With all bolts tightened, verify the hinge brackets and inner door brackets have appropriate clearances with the body while slowly opening and closing both rear doors. Adjust as needed.
28. Reinstall the weather stripping on the inside seam of the door.
29. Mark and cut the weather-stripping to fit around the inner driver door bracket. On the weather-stripping, cut the channel (attachment to the folded sheet metal) and not the bulb (hollow tube); (Reference Figure 12 & 13). Tin snips work best for cutting through the weather-stripping, but a cut-off wheel can also be used.



Figure 12: Area to Cut on Weather-Stripping (Bracket Removed for Visualization)

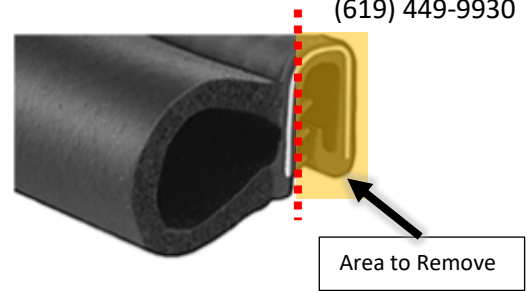

Figure 13: Cross-Section of Weather-Stripping

30. Reinstall weather-stripping over the bracket ensuring cut section lines up with bracket. Fully re-seat the weather-stripping.
31. To mount a tire or box, the Tire/Box Carrier (P/N 210537) components must be purchased separately.
32. Check mounting hardware after first 100 miles of driving and periodically thereafter.
33. Your new Aluminess ladder is now installed, enjoy!



Aluminess Products, Inc. (Aluminess) Warranty

1. Lifetime Warranty. Aluminess provides a lifetime warranty of its products to the original retail purchaser provided such products are installed correctly according to the official Aluminess installation instructions. Any modification to the original product design, function or use of any Aluminess products will void the Aluminess warranty. Aluminess will have sole discretion to determine warranty eligibility for any and all Aluminess products sold to any purchaser.

2. Limited Remedies. Subject to any limitations and exclusions described herein, and subject to Aluminess' determination of warranty eligibility, Aluminess will remedy defects in product materials and/or workmanship of any product by repairing or replacing such defective product, which shall be within Aluminess' sole discretion, without charge for parts or labor. Aluminess may elect in its sole discretion not to replace a defective product and issue the purchaser a refund equal to the purchase price of any defective product or purchaser may elect to receive a credit (equal to such refund) toward the purchase of new Aluminess products. Repair or replacement of a defective product or providing a refund or credit to purchaser will be purchaser's exclusive remedy under this warranty. Damage to a purchaser's vehicle, cargo and/or any other person or property is expressly excluded from the Aluminess warranty.

3. Modification. Aluminess products are designed to be mounted to factory equipped vehicles. Aftermarket additions to such vehicle may or may not require modification of an Aluminess product. The Aluminess warranty does not extend to any Aluminess products that are modified to fit around other otherwise accommodate or be compatible with any aftermarket vehicle accessories or alterations. Aluminess does not guarantee fitment with any other aftermarket accessories or modified vehicle, and it is up to purchaser to determine fitment prior to purchasing any Aluminess product.

4. Damage. Damage to Aluminess products due to normal wear and tear, including, but not limited to, cosmetic issues and superficial scratches, or structural damage to an Aluminess product in connection with any vehicle collisions or other structural degradation in connection with the use of such vehicle (on road or off road) will not be covered by the Aluminess warranty. Additionally, any product user's misuse, neglect, overloading, improper maintenance or improper installation or repair of any Aluminess products are not covered under the Aluminess warranty.

5. Use of the Products. Aluminess products are designed for off road vehicle use. Installing Aluminess products on a vehicle may exceed the factory designed capabilities of such vehicle and could potentially lead to vehicle damage. Aluminess will not be responsible for any damage caused to a purchaser or user's vehicle or any vehicle accessories caused by the use of any Aluminess products. It is to the sole responsibility of purchaser to inspect and ensure that the intended vehicle and Aluminess products are suitable and compatible for travel on road and off road. No seller nor any manufacturer of Aluminess products will be liable for any loss, damage or injury directly or indirectly arising from the use of any Aluminess products. Before using any Aluminess products, the purchaser or user will determine the suitability of the product(s) for their intended use(s) and the purchaser or user shall assume all responsibility and risk in connection therewith.

6. DISCLAIMER. THE ALUMINESS WARRANTY IS EXPRESSLY MADE IN LIEU OF ANY AND ALL OTHER WARRANTIES, AND EXCEPT FOR THE ALUMINESS WARRANTY SET FORTH HEREIN, ALUMINESS MAKES NO WARRANTY WHATSOEVER WITH RESPECT TO ANY ALUMINESS PRODUCT, INCLUDING ANY WARRANTY OF MERCHANTABILITY AND FITNESS FOR A PARTICULAR PURPOSE, WHETHER EXPRESS OR IMPLIED BY LAW, COURSE OF DEALING, COURSE OF PERFORMANCE, USAGE OF TRADE, OR OTHERWISE.

EXCEPT FOR PURCHASER'S LIMITED REMEDIES SET FORTH HEREIN, IN NO EVENT WILL ALUMINESS BE LIABLE FOR ANY LOST PROFITS, LOST SALES, OR FOR ANY CONSEQUENTIAL, DIRECT, INDIRECT, INCIDENTAL, SPECIAL, EXEMPLARY OR PUNITIVE DAMAGES OR FOR ANY OTHER DAMAGES OF ANY KIND OR NATURE.

7. Compliance. Aluminess cannot guarantee that its products comply with all Federal, State, and/or local laws. Purchaser is advised to review local vehicle codes for compatibility prior to purchase to ensure that the installation and use of any Aluminess products does not violate any applicable laws.

8. Warranty Claim Submission. Purchaser will responsible for returning any defective product to Aluminess for warranty consideration and purchaser may be responsible for all costs associated with shipping the product to and from Aluminess. Prior to returning any product for warranty, purchaser must contact Aluminess Products Inc. for proper authorization