

Rear Door Base Unit Installation Instructions

P/N 210579: 2015+ Ford Transit Rear Door Base Unit, Passenger

Before you begin:

- *Stainless steel hardware may bind together when tightening — apply an anti-seize assembly lubricant to the threads of each bolt before assembly.*
- *This installation requires two or more people*

Required Tools:



- Standard and metric wrench set
- Standard and metric socket set
- Torx bit set
- Drill or impact driver
- Isopropyl Alcohol
- Baby Soap or Dish Soap
- Spray Bottle
- Clean Rag
- Squeegee (or old credit card)

Included Hardware:

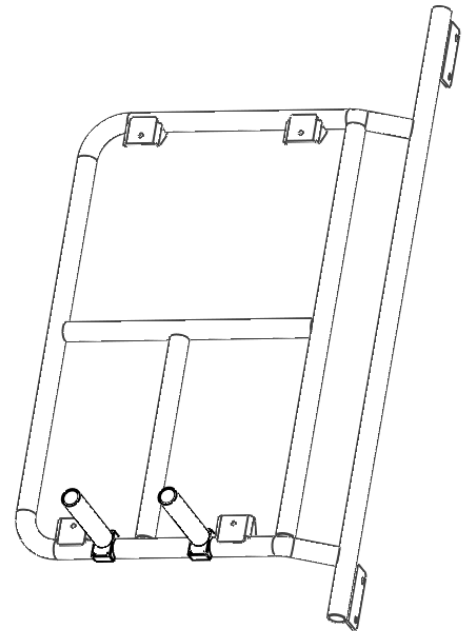
<u>P/N</u>	<u>Description</u>	<u>Quantity</u>
70344	5/16"-18 x 1" Button Head Bolt, BLACK OXIDE	4
70446	5/16"-18 x 1 1/4" Button Head Bolt, BLACK OXIDE	4
70448	3/8" ID Washer, 1/8" THK, BLACK OXIDE	4
70345	5/16" ID Washer, BLACK OXIDE	16
70346	5/16"-18 Nylon-Locking Nut, BLACK OXIDE	8
70094	1/4"-20 x 3/4" Button Head Bolt	4
70008	1/4"-20 Nylon-Locking Nut	8
70009	1/4" ID Washer	12
70038	1/4"-20 X 2 3/4" Philips head screw, SS	4
70040	1/4" Countersunk Washer, SS	4
70039	1/4" X 1 Fender Washer, SS	4
70437	M6-1.0 x 16mm, Button Head Bolt	3
70246	Antiseize Bolt Lubricant Packet, 2g	1
400999	Impact Resistant Protective Tape	18"

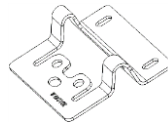

Additional Parts:

<u>PN</u>	<u>Description</u>	<u>Quantity</u>	<u>Picture</u>
301249/350656	Upper Hinge Bracket	1 ea	
301250/350657	Lower Hinge Bracket	1 ea	

301497/350644	Inner Door Bracket, Passenger	1 ea
301255/350648	Inner Passenger Door Bracket, Upper	1 ea
350662	8" Tire Support Post	2 ea

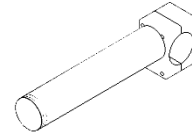
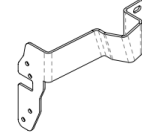
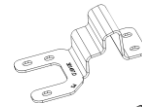

Base Unit Rack Installation:

1. Cut the supplied protective tape into one - 6" section and one - 3" section. Round all corners.

PRO TIP: Dry fit each bracket to verify shape and location of protective tape before cutting. Be sure to cut tape in correct orientation, with white backing towards vehicle.

2. Apply the protective tape to each location, one at a time, using the following wet application technique described below.
3. Prepare the surface for protective film application (wet application technique):
 - a. Clean the area around each hinge with isopropyl alcohol and rag.
 - b. Wash your hands thoroughly.
 - c. Do not apply in direct sunlight
 - d. Apply in temperatures above 60°F.
 - e. Create two separate wetting solutions:
 - i. Soap/water: ~95% water / ~5% soap
 - ii. Alcohol/water: ~75% water, ~25% isopropyl alcohol
4. Spray the surface thoroughly with soap/water solution and do not wipe down surface.
5. Remove the liner from the protective tape while spraying the adhesive side with soap/water solution.

6. Apply the protective tape to the outside of the door at each location where the brackets contact the vehicle (Figure 1). At each location, leave approximately 1/2" of tape overhanging to be wrapped around the edge of the door.



Figure 1: Locations of Protective Film Application

7. Use squeegee all air bubbles out starting at adhered edge.
8. Use the alcohol/water solution to speed up adhesion at one edge (lift section up and spray adhesive side) as needed.
9. Wrap remaining protective tape around the door underneath hinge if possible.

10. Install the upper hinge bracket by:
- Have someone help support the weight of the door throughout the entire bracket installation.
 - Remove the three bolts connecting the hinge to the door.
 - Rotate hinge enough to allow the bracket to be installed around the hinge (Figure 2).



Figure 2: Upper Hinge Rotated Away from Door

- Install the bracket around the hinge in the correct orientation (Figure 3).



Figure 3: Bracket Installed Over Factory Hinge

- Rotate the hinge and bracket back into position against the door (Figure 4).



Figure 4: Hinge Placed Back into Position

- Use the factory hardware to reinstall the hinge/bracket (Figure 5).

PRO TIP: When reinstalling factory hardware, try to match up the location of the hinge to the door using the unpainted 'shadow' as a guide to ensure proper alignment of the door on the van. Misalignment of the hinges can lead to fitment issues at the inner door latch.

PRO TIP: Be sure to center the bracket around the hinge and verify clearances around the hinge while opening and closing the door.



Figure 5: Inside View of Installed Upper Hinge

11. Install the lower hinge bracket by repeating the process detailed in Step 10 (reference Figure 6).



Figure 6: Inside View of Installed Lower Hinge Bracket

12. Remove the three (3) factory torx bolts holding on the passenger's side latch. NOTE: Prevent the latch from falling into the door by holding the inside latch (Figure 7 & 8).



Figure 7: Inside Latch on Passenger Door



Figure 8: Installed Inner Passenger Door Bracket

13. Install the inner passenger door bracket using the provided M6-1.0 hardware and ¼" ID washer (See Figure 8).
14. Determine if there is an upper handle present on the inside of the passenger door (Figure 9).

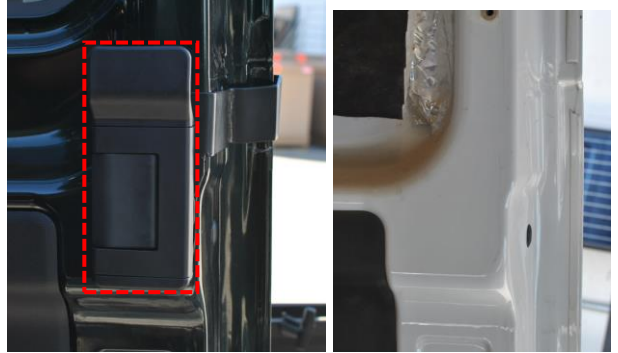

Figure 9: Inside Upper Handle - Present (left) or Not Present (right)

15. If there is an upper inside handle (2020+), skip to step 16. If there is no handle present (2015-2019), complete the following:
 - a. Remove any door plastic coverings to gain access to inside of the door.
 - b. Peel back inside door liner if applicable (Figure 10).



Figure 10: Inner Door Liner Peeled Back for Access

- c. Dry fit bracket to door (Figure 11).



Figure 11: Dry Fit Bracket Up to Door

NOTE: It may be helpful to loosely bolt on the rack at this point to confirm placement of upper inner bracket. Align the two sets of slotted holes. The jog of the sheet metal on the inside of the doorjamb can be used for rough alignment.

- d. Mark four (4) mounting hole locations. Measure twice, cut once!
- e. Drill a ¼" hole at the marked locations.
- f. Paint any exposed metal as desired.
- g. Install inside bracket with ¼"-20 hardware (Figure 12).



Figure 12: Installed Inside Upper Bracket without Factory Handle

- h. Reseal liner and replace plastic coverings.
- 16. If passenger door does have the upper inside handle, complete the following:
 - a. Remove the plastic cover by prying from the side with a flathead screwdriver (Figure 13).



Figure 13: Inside Upper Plastic Cover

- b. Remove the plastic handle by loosening the two (2) exposed bolts with a 7mm socket (Figure 14).

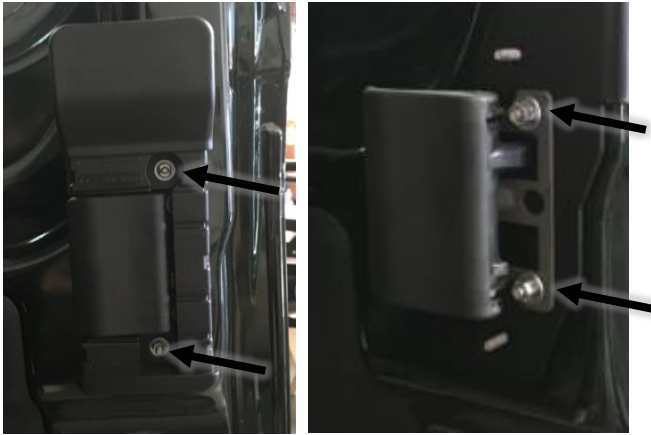

Figure 14: Plastic Handle (left) and Latch Handle (right)

- c. Remove the latch handle by loosening the two (2) remaining 7mm nuts (Figure 14).
- d. Install Upper, Inner Passenger's Side Door Bracket and reuse factory hardware to reinstall handle and covers. Sandwich the bracket between the door and the latch handle (Figure 15).



Figure 15: Upper Inner Passenger's Side Bracket Installed

- 17. Loosely install the base unit onto the upper, lower, and inner brackets using the provided 5/16"-18 bolts, washers, and nuts. Use the 1" bolts for the outer brackets and the 1 1/4" bolts for the inner bracket.

- a. Tighten the upper and lower **hinge** brackets first.
- b. There should be a small gap at the center bracket before it is fully tightened (0-1/8"). If the gap is larger, than 1/8", use the provided 1/8" THK washers as shims (PN: 70448) to close the gap to $\leq 1/8"$ (See Figure 16).



Figure 16: Example of gap between bracket and rack

- 18. Verify the hinge brackets and inner door brackets have appropriate clearances while slowly opening and closing both rear doors. Adjust as needed.
- 19. If mounting a box is desired, grab your included 8" support posts [350662]. Unscrew the bolts holding the pipe clamp together, and place the posts facing out on the bottom of the pipe of the base unit. Adjust the posts so that they are level with the van and evenly spaced over where you want the box to sit. Tighten the pipe clamp support posts down.
- 20. Mark and drill 5/16" holes through the back of your box into the cross pipe in the middle of the base unit, and through the bottom of the box into the support posts. Secure box to rail using the hardware shown in figures 17 and 18 below.

21. Your new Aluminess Base Unit Rack is now installed, enjoy!

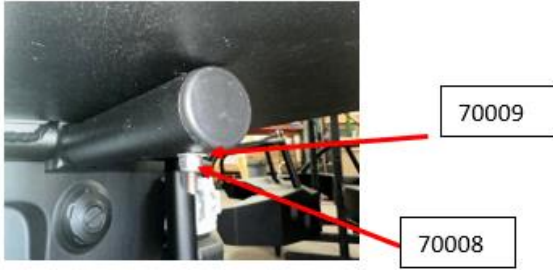

Figure 17: Mounting Hardware Under Box

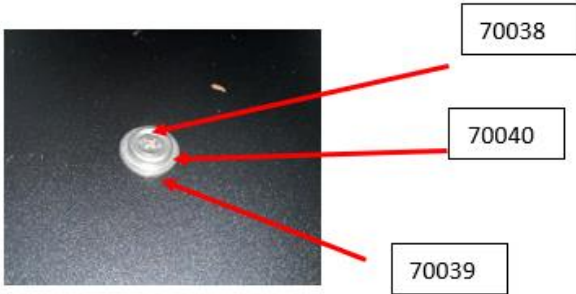

Figure 18: Mounting Hardware Inside Box



Aluminess Products, Inc. (Aluminess) Warranty

1. Lifetime Warranty. Aluminess provides a lifetime warranty of its products to the original retail purchaser provided such products are installed correctly according to the official Aluminess installation instructions. Any modification to the original product design, function or use of any Aluminess products will void the Aluminess warranty. Aluminess will have sole discretion to determine warranty eligibility for any and all Aluminess products sold to any purchaser.

2. Limited Remedies. Subject to any limitations and exclusions described herein, and subject to Aluminess' determination of warranty eligibility, Aluminess will remedy defects in product materials and/or workmanship of any product by repairing or replacing such defective product, which shall be within Aluminess' sole discretion, without charge for parts or labor. Aluminess may elect in its sole discretion not to replace a defective product and issue the purchaser a refund equal to the purchase price of any defective product or purchaser may elect to receive a credit (equal to such refund) toward the purchase of new Aluminess products. Repair or replacement of a defective product or providing a refund or credit to purchaser will be purchaser's exclusive remedy under this warranty. Damage to a purchaser's vehicle, cargo and/or any other person or property is expressly excluded from the Aluminess warranty.

3. Modification. Aluminess products are designed to be mounted to factory equipped vehicles. Aftermarket additions to such vehicle may or may not require modification of an Aluminess product. The Aluminess warranty does not extend to any Aluminess products that are modified to fit around other otherwise accommodate or be compatible with any aftermarket vehicle accessories or alterations. Aluminess does not guarantee fitment with any other aftermarket accessories or modified vehicle, and it is up to purchaser to determine fitment prior to purchasing any Aluminess product.

4. Damage. Damage to Aluminess products due to normal wear and tear, including, but not limited to, cosmetic issues and superficial scratches, or structural damage to an Aluminess product in connection with any vehicle collisions or other structural degradation in connection with the use of such vehicle (on road or off road) will not be covered by the Aluminess warranty. Additionally, any product user's misuse, neglect, overloading, improper maintenance or improper installation or repair of any Aluminess products are not covered under the Aluminess warranty.

5. Use of the Products. Aluminess products are designed for off road vehicle use. Installing Aluminess products on a vehicle may exceed the factory designed capabilities of such vehicle and could potentially lead to vehicle damage. Aluminess will not be responsible for any damage caused to a purchaser or user's vehicle or any vehicle accessories caused by the use of any Aluminess products. It is to the sole responsibility of purchaser to inspect and ensure that the intended vehicle and Aluminess products are suitable and compatible for travel on road and off road. No seller nor any manufacturer of Aluminess products will be liable for any loss, damage or injury directly or indirectly arising from the use of any Aluminess products. Before using any Aluminess products, the purchaser or user will determine the suitability of the product(s) for their intended use(s) and the purchaser or user shall assume all responsibility and risk in connection therewith.

6. DISCLAIMER. THE ALUMINESS WARRANTY IS EXPRESSLY MADE IN LIEU OF ANY AND ALL OTHER WARRANTIES, AND EXCEPT FOR THE ALUMINESS WARRANTY SET FORTH HEREIN, ALUMINESS MAKES NO WARRANTY WHATSOEVER WITH RESPECT TO ANY ALUMINESS PRODUCT, INCLUDING ANY WARRANTY OF MERCHANTABILITY AND FITNESS FOR A PARTICULAR PURPOSE, WHETHER EXPRESS OR IMPLIED BY LAW, COURSE OF DEALING, COURSE OF PERFORMANCE, USAGE OF TRADE, OR OTHERWISE.

EXCEPT FOR PURCHASER'S LIMITED REMEDIES SET FORTH HEREIN, IN NO EVENT WILL ALUMINESS BE LIABLE FOR ANY LOST PROFITS, LOST SALES, OR FOR ANY CONSEQUENTIAL, DIRECT, INDIRECT, INCIDENTAL, SPECIAL, EXEMPLARY OR PUNITIVE DAMAGES OR FOR ANY OTHER DAMAGES OF ANY KIND OR NATURE.

7. Compliance. Aluminess cannot guarantee that its products comply with all Federal, State, and/or local laws. Purchaser is advised to review local vehicle codes for compatibility prior to purchase to ensure that the installation and use of any Aluminess products does not violate any applicable laws.

8. Warranty Claim Submission. Purchaser will responsible for returning any defective product to Aluminess for warranty consideration and purchaser may be responsible for all costs associated with shipping the product to and from Aluminess. Prior to returning any product for warranty, purchaser must contact Aluminess Products Inc. for proper authorization.